



It's Hard To Stop A Trane.®

Owner's Guide

Indoor Units:

Air Handlers

Gas Furnaces



32-5064-WEB01

Proper Maintenance – Air Handlers

⚠ CAUTION

To prevent injury or death, or property damage, read and follow all instructions and warnings, including labels shipped with or attached to unit before operating your new air conditioning system.

⚠ WARNING

Improper installation, adjustment, alteration, service maintenance, or use can cause explosion, fire, electrical shock, or other conditions which may cause personal injury or property damage. Consult a qualified installer or service agency for information or assistance. The qualified installer or agency must use factory-authorized kits or accessories when modifying this product.

⚠ WARNING

Disconnect all electric power to the indoor air handler or furnace before removing access panels to perform any maintenance. Disconnect power to both the indoor and outdoor units.

A clean filter saves money.

Help ensure top efficiency by cleaning the filter regularly.

When the unit circulates and filters the air in your home, dust and dirt particles collect on the filter located in your indoor unit. Excessive buildup forces the system to run longer to maintain your set temperature. And you end up paying for it.

⚠ CAUTION

Although special care has been taken to minimize sharp edges in the construction of the unit, be extremely careful when handling parts or reaching into the unit.

Clean or replace your filter at least once a month or twice a month when the system is running more.

If you have a semi-permanent filter, you can take the filter out of the frame and vacuum it. Where disposable filters are used, they must be replaced every month with the same size as originally supplied.

Both methods are quick and easy and guaranteed to cut the energy used by your system. When replacing your air handler filters, always use the same size and type that was originally supplied. Filters are available from your dealer.

Your filter may or may not be framed.

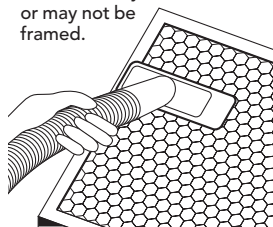

Cut operating costs by keeping snow, ice and debris clear of your outdoor heat pump unit.

NOTE: Condensation may occur on the surface of the air handler when installed in an unconditioned location.

Efficient operation of your outdoor unit requires the free flow of air over the coils. Anything that blocks this flow forces the unit to work harder to do its job. At no time should anything be stacked against the side of the outdoor unit or draped over it. Keeping it clear of debris helps it work at peak efficiency, and that helps hold down operating costs.

Don't waste money heating and cooling when you don't need to.

When you're going to be away from home for a few days – or when outdoor temperatures are moderate – don't let your system run unnecessarily. Lower the thermostat to 55°F in the winter. And raise it to 85°F in summer. Then when you return – or when temperatures dictate – you can reset the system and it will immediately begin making your home comfortable again. Continuous fan mode during cooling operation may not be appropriate in humid climates. If the indoor air exceeds 60% relative humidity or simply feels uncomfortably humid, it is recommended that the fan only be used in the AUTO mode.

⚠ CAUTION

If heating system is not operational during the cold weather months, provisions must be taken to prevent freeze-up of all water pipes and water receptacles. This is very important during times of vacancy.

Never stop the system by shutting off the main power.

If the main power is ever disconnected for more than three hours, turn off the thermostat. Then wait for at least three more hours after the power has been restored before turning the thermostat back on. Failure to follow this procedure could result in damage to your system.

How to remove the filter from your Air Handler.

Ask your dealer where the filter is located when your system is installed. It may be behind the bottom panel of your indoor unit. Or it may be at the top, bottom, or either side. Or there may be two filters.

In any case, removing a filter is easy. Just make sure you insert the clean filter with the arrows on it pointing in the direction of the airflow.

Your installing dealer is your best source of filter and maintenance information.

Locate access door marked "FILTER" and lift up the open side of the levers.

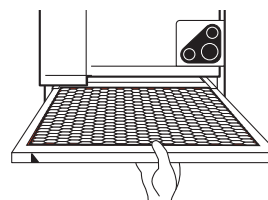
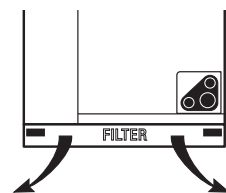

Slide dirty filter out, replace with a new filter making sure the arrows printed on it are pointing in the direction of airflow.

Hold the "FILTER" door firmly in place and snap the levers down (closed).

For regular dealer maintenance please refer to www.acca.org/industry/quality

The Problem Solver – Air Handlers

Before you call for service, check the following:

Problem	Possible cause	Possible Remedy
Insufficient heating or cooling	<ol style="list-style-type: none"> 1. Dirty filters 2. Air not circulating freely 3. Blocked outdoor coil 	<ol style="list-style-type: none"> 1. Clean or replace 2. Check supply registers and return grills for blockage 3. Clear away leaves or other debris
Failure to operate	<ol style="list-style-type: none"> 1. Power off 2. Open circuit breaker or burned-out fuses 3. Improperly adjusted thermostat 	<ol style="list-style-type: none"> 1. Make sure main switch is in on position 2. Reset circuit breaker, or replace burned-out fuses 3. Check setting, adjust thermostat
Unusual Noise		Call your local servicer

CAUTION

Whenever your house is to be vacant, arrange to have someone inspect your house for proper temperature. This is very important in below freezing weather. If for any reason your unit should fail to operate, damage could result, such as frozen water pipes.

NOTE: Improperly sized vents can cause the formation of condensate, combustion gas leakage and spillage, and an inoperable furnace.

This unit is not a household appliance. It is a complex self-contained system that requires professional maintenance and repair. That's why attempts at do it yourself repairs on an in-warranty unit may void the remainder of your warranty. Other than performing the simple maintenance recommended in this manual, you should not attempt to make any adjustments to your system.

NOTE: The blower motor bearings are factory lubricated and under normal operating conditions usually do not require servicing. Your local servicer can advise you if oiling is required. Your dealer should be able to take care of any questions or problems you may have.

Keep your unit looking like new for years.

Clean the enamel finish of your unit with ordinary soap and water. For stubborn grease spots, use a household detergent. Lacquer thinner or other synthetic solvents may damage the finish.

Just set the temperature you want.

Set temperatures by using the indicators on the thermostat* control. After that, your comfort control center (thermostat) will maintain a constant indoor temperature, regardless of changes in outdoor temperatures. Read your thermostat manual for directions on setting the temperatures.

Save energy with an electronic programmable thermostat.

With an electronic programmable thermostat* energy savings is easy. Just program the thermostat for the temperatures you are most comfortable with and it will automatically change settings up to four times a day. Special weekend and vacation schedules are also easily programmed for comfort and savings. Read your thermostat manual for programming instructions. If you want the optimum balance between comfort and the cost of running your system, we recommend keeping the temperature settings at 68°F for heating and 78°F for cooling.

Save energy by letting the thermostat do its job. Once you set the thermostat, keep subsequent adjustments to a minimum. Adjust it only when a new program is needed.

*Optional accessory

Limited Warranty Information

Subject to the terms and conditions of this limited warranty, Trane U.S., Inc. ("Company") extends a limited warranty against manufacturing defects for the product(s) identified in Table 1 attached hereto ("Products") that are installed in a residential application (personal, family or household purposes) under normal use and maintenance in the United States and Canada.

This limited warranty applies to Products manufactured on or after August 1, 2011.

In order to maximize the available benefits under this limited warranty, the Purchaser (as defined below) should read it in its entirety. All repairs of Product parts covered under this limited warranty must be made with authorized service parts and by a licensed HVAC service provider. Additionally, commercial applications are treated differently under this limited warranty as stated in Table 1 attached hereto. For purposes of this limited warranty, "commercial applications" shall mean any application other than for personal, family, or household use.

TERM: The limited warranty period for Products is as stated in Table 1 attached hereto. If the Purchaser properly registers the Products, the limited warranty period shall be extended as stated in Table 1 attached hereto. Regardless of registration, the Commencement Date for a limited warranty period shall be the date that the original installation is complete and all Product start-up procedures have been properly completed and verified by an installer's invoice. If the installation and start-up date cannot be verified by the installer's invoice, the Commencement Date shall be sixty (60) days after the factory manufacture date which is verified by the Product serial number. Where a Product is installed in a newly constructed home, the Commencement Date is the date the Purchaser purchased the residence from the builder. Proof of Product purchase, installation, and/or closing date of the residence may be required to confirm the Commencement Date.

The installation of Product replacement parts under this limited warranty shall not extend the original warranty period. The warranty period for any Product part replaced under this limited warranty is the applicable warranty period remaining under the original Product warranty.

WHO IS COVERED: This limited warranty is provided only to the original owner and his or her spouse ("Purchaser") of the residence where the Products are originally installed. This warranty is not transferable except according to terms stated on the applicable website identified below under Registration Requirements. Company has the right to request any and all proof of Product purchase or installation and/or closing date of the residence.

WHAT COMPANY WILL DO: Company may request proof of Product purchase and/or installation in order to provide Product parts under this limited warranty. As Company's only responsibility and Purchaser's only remedy under this limited warranty, Company will furnish a replacement part to the licensed HVAC service provider, without charge for the part only, to replace any Product part that fails due to a manufacturing defect under normal use and maintenance. The Purchaser must pay for any and all shipping and handling charges and other costs of warranty service for the replacement part. If a Product part is not available, Company will, at its option, provide a free suitable substitute part or provide a credit in the amount of the then factory selling price for a new suitable substitute part to be used by the Purchaser towards the retail purchase price of a new Company product. Any new Product purchase shall be at Purchaser's sole cost and expense including, but not limited to, all shipping, removal, and installation costs and expenses.

REGISTRATION REQUIREMENTS: All Products must be properly registered online by the Purchaser within sixty (60) days after the Commencement Date to receive the registered limited warranty terms. To register online, go to:

<http://www.trane.com/Residential/Trane/Owners/Warranty-Information> or
<http://www.americanstandardair.com/servicesupport/pages/warranty.aspx>

and click "Begin Online Registration." If a Purchaser does not register within this stated time period, the base limited warranty terms shall apply.

ELIGIBILITY REQUIREMENTS: The following items are required in order for the Products to be covered under this limited warranty:

- The Products must be in the same location where they were originally installed.
- The Products must be properly installed, operated, and maintained by a licensed HVAC service provider in accordance with the Product specifications or installation, operation, and maintenance instructions provided by Company with each Product. Failure to conform to such specifications and/or instructions shall void this limited warranty. Company may request written documentation showing the proper preventative maintenance.
- All Product parts replaced by Company under this limited warranty must be given to the servicing provider for return to Company.

- Air handlers, air conditioners, heat pumps, cased or uncased coils and stand-alone furnaces must be part of an Air Conditioning, Heating, and Refrigeration Institute rated and matched system or a specification in a Company provided bulletin or otherwise approved in writing by a Company authorized representative.

EXCLUSIONS: The following are not covered by this limited warranty:

- Labor costs including, but not limited to, costs for diagnostic calls or the removal and reinstallation of Products and/or Product parts.
- Shipping and freight expenses required to ship Product replacement parts.
- Failures, defects, or damage (including, but not limited to, any loss of data or property) caused by (1) any third party product, service, or system connected or used in conjunction with the Products; (2) any use that is not designed or intended for the Products; (3) modification, alteration, abuse, misuse, negligence, or accident; (4) improper storage, installation, maintenance, or operation including, but not limited to, operation of electrical equipment at voltages other than the range specified on the Product nameplate; (5) any use in violation of written instructions or specifications provided by Company; (6) any acts of God including, but not limited to, fire, water, storms, lightning, or earthquakes; or any theft or riots; or (7) a corrosive atmosphere or contact with corrosive materials such as, but not limited to, chlorine, fluorine, salt (provided that indoor and outdoor coils will only be covered if a Sea Coast Kit is installed), sulfur, recycled waste water, urine, fertilizers, rust, or other damaging substances or chemicals.
- Products purchased direct including, but not limited to, Internet or auction purchases and purchases made on an uninstalled basis.
- 3 phase models, cabinets or cabinet pieces that do not affect product performance, air filters, refrigerant, refrigerant line sets, belts, wiring, fuses, surge protection devices, non-factory installed driers, and Product accessories.
- Increased utility usage costs.

REFRIGERANT POLICY: Beginning on January 1, 2010, R-22 refrigerant will no longer be used

as a manufacturer-installed refrigerant as required by federal regulation. Any and all expenses or costs associated with replacing Product parts that are not R-410A compatible will not be covered by the terms and conditions of this limited warranty. In addition, all Products containing R-410A refrigerant include a liquid line filter drier which must be replaced when a compressor replacement is necessary. A suction line filter drier must be added for compressors defined as burnouts. Failure to comply with such filter drier requirements or the use of contaminated or alternate refrigerant or any non-approved refrigerant system additives including, but not limited to, dyes, will void this limited warranty.

ADDITIONAL TERMS:

THIS LIMITED WARRANTY AND LIABILITY SET FORTH HEREIN ARE IN LIEU OF ALL OTHER WARRANTIES AND LIABILITIES, WHETHER IN CONTRACT OR IN NEGLIGENCE, EXPRESS OR IMPLIED, IN LAW OR IN FACT. THE IMPLIED WARRANTIES OF MERCHANTABILITY AND FITNESS FOR A PARTICULAR PURPOSE ARE LIMITED TO THE DURATION OF THE APPLICABLE PRODUCT WARRANTY. COMPANY DOES NOT AUTHORIZE ANY PERSON TO CREATE FOR IT ANY OBLIGATION OR LIABILITY IN CONNECTION WITH THE PRODUCTS.

NOTWITHSTANDING ANYTHING IN THIS LIMITED WARRANTY TO THE CONTRARY, COMPANY SHALL NOT BE LIABLE FOR ANY INCIDENTAL, CONSEQUENTIAL, INDIRECT, SPECIAL AND/OR PUNITIVE DAMAGES, WHETHER BASED ON CONTRACT, WARRANTY, TORT (INCLUDING, BUT NOT LIMITED TO, STRICT LIABILITY OR NEGLIGENCE), PATENT INFRINGEMENT, OR OTHERWISE, EVEN IF ADVISED OF THE POSSIBILITY OF SUCH DAMAGES. COMPANY'S MAXIMUM LIABILITY HEREUNDER IS LIMITED TO THE ORIGINAL PURCHASE PRICE OF THE PRODUCTS.

No action arising out of any claimed breach of this limited warranty may be brought by a Purchaser more than one (1) year after the cause of action has arisen.

This limited warranty gives you specific legal rights, and you may also have other rights as otherwise permitted by law. If this Product is considered a consumer product, please be advised that some local laws do not allow limitations on incidental or consequential damages, how long a warranty lasts based on registration, or how long an implied warranty lasts, so that the above limitations may not fully apply. Refer to your local laws for your specific rights under this limited warranty.

Residential Systems
6200 Troup Highway, Tyler, TX 75707
Attn: Customer Relations

Or visit our website at www.trane.com or www.americanstandardair.com

Safety Section – Gas Furnaces

IMPORTANT: Users MUST read all instructions in the manual. All manuals MUST be kept for future reference.

WARNING

FIRE OR EXPLOSION HAZARD

If the information in this manual is not followed exactly, a fire or explosion may result causing property damage, personal injury or loss of life.

— Do NOT store or use gasoline or other flammable vapors and liquids or combustible materials in the vicinity of this or any other appliance.

— WHAT TO DO IF YOU SMELL GAS

- Do not try to light any appliance.
- Do not touch any electrical switch; do not use any phone in your building.
- Immediately call your gas supplier from a neighbor's phone. Follow the gas supplier's instructions.
- If you cannot reach your gas supplier, call the fire department.

— DO NOT RELY ON SMELL ALONE TO DETECT LEAKS. DUE TO VARIOUS FACTORS, YOU MAY NOT BE ABLE TO SMELL FUEL GASES.

- U.L. recognized fuel gas and CO detectors are recommended in all applications, and their installation should be in accordance with the manufacturer's recommendations and/or local laws, rules, regulations, or customs.

— Installation and service must be performed by a qualified installer, service agency or the gas supplier.

Safety signal words are used to designate a degree or level of seriousness associated with a particular hazard. The signal words for safety markings are **WARNING** and **CAUTION**.

- a. **WARNING** indicates a potentially hazardous situation which, if not avoided, could result in death or serious injury.
- b. **CAUTION** indicates a potentially hazardous situation which, if not avoided, may result in minor or moderate injury. It is also used to alert against unsafe practices and hazards involving only property damage.

WARNING

EXPLOSION HAZARD

Do not use this unit if any part has been under water. A flood damaged unit is extremely dangerous. Attempts to use the furnace can result in fire or explosion. A qualified service agency should be contacted to inspect the furnace and to replace all gas controls, control system parts, electrical parts that have been wet or the furnace if deemed necessary.

Failure to follow this warning could result in property damage, personal injury or death.

WARNING

EXPLOSION HAZARD

In the event that electrical, fuel or mechanical failures occur, shut off the gas supply at the manual gas shut off valve, located on the supply gas piping coming into the furnace, before turning off the electrical power to the furnace. Contact servicer.

Failure to follow this warning could result in property damage, personal injury or death.

WARNING

CARBON MONOXIDE POISONING HAZARD

Failure to follow the installation and operation instructions for the venting system's operation could result in carbon monoxide poisoning or death.

WARNING

EXPLOSION HAZARD

Should overheating occur, or the gas supply fail to shut off, shut off the manual gas valve to the furnace before shutting off the electrical supply.

Failure to follow this warning could result in property damage, personal injury or death.

The following warning complies with State of California law, Proposition 65.

WARNING

THIS PRODUCT CONTAINS FIBERGLASS WOOL INSULATION!

Fiberglass dust and ceramic fibers are believed by the State of California to cause cancer through inhalation. Glasswool fibers may also cause respiratory, skin, or eye irritation.

PRECAUTIONARY MEASURES

- Avoid breathing fiberglass dust.
- Use a NIOSH approved dust/mist respirator.
- Avoid contact with the skin or eyes. Wear long-sleeved, loose-fitting clothing, gloves, and eye protection.
- Wash clothes separately from other clothing: rinse washer thoroughly.
- Operations such as sawing, blowing, tear-out, and spraying may generate fiber concentrations requiring additional respiratory protection. Use the appropriate NIOSH approved respirator in these situations.

FIRST AID MEASURES

- Eye Contact – Flush eyes with water to remove dust. If symptoms persist, seek medical attention.
- Skin Contact – Wash affected areas gently with soap and warm water after handling.

WARNING

SAFETY HAZARD

Bodily injury can result from high voltage electrical components, fast moving fans, and combustible gas. During installation and servicing, the electrical supply must be disconnected and the main gas valve must be turned off.

Failure to follow this warning could result in property damage, personal injury or death.

Safety Section – Gas Furnaces

⚠ WARNING

BURN HAZARD

Do not attempt to manually light the furnace. Failure to follow this warning could result in property damage, personal injury or death.

⚠ CAUTION

The furnace is equipped with a blocked vent shut-off system. When the furnace vent is blocked, a pressure switch will shut off the furnace. Call a qualified servicer.

⚠ WARNING

SAFETY HAZARD

Improper installation, adjustment, alteration, service or maintenance can cause injury or property damage. See regular maintenance on page 9 for annual general inspection. For assistance or additional information consult a qualified installer, service agency or the gas supplier. Failure to follow this warning could result in property damage, personal injury or death.

⚠ WARNING

EXPLOSION HAZARD

Propane gas is heavier than air and may collect in any low areas or confined spaces. In addition, odorant fade may make the gas undetectable except with a warning device. If the gas furnace is installed in a basement, an excavated area or a confined space, it is strongly recommended to contact a gas supplier to install a gas detecting warning device in case of a gas leak. The manufacturer of your furnace does not test any detectors and makes no representations regarding any brand or type of detector.

⚠ CAUTION

Never operate your unit for either heating or cooling with filters removed.

⚠ CAUTION

SAFETY HAZARD

Sharp Edge Hazard. Be careful of sharp edges on equipment or any cuts made on sheet metal while installing or servicing. Personal injury may result.

⚠ WARNING

ELECTRIC SHOCK HAZARD

These servicing instructions are for use by qualified personnel only. To reduce the risk of electric shock, do not perform any servicing other than that contained in these operating instructions unless you are qualified to do so.

Failure to follow this warning could result in property damage, personal injury or death.

⚠ WARNING

CARBON MONOXIDE HAZARD

For proper and safe operation of the furnace, air for combustion and ventilation must be provided. Do not block or obstruct air openings on the furnace, air openings to the area in which the furnace is installed, or the space around the furnace.

Failure to follow this warning could result in property damage, personal injury or death.

⚠ WARNING

EXPLOSION HAZARD

Should overheating occur, or the gas supply fail to shut off, shut off the manual gas valve to the furnace before shutting off the electrical supply.

Failure to follow this warning could result in property damage, personal injury or death.

⚠ CAUTION

If the furnace is shut down during the cold weather months, provisions must be taken to prevent freeze-up of all water pipes and water receptacles.

⚠ CAUTION

Do NOT touch igniter. It is extremely hot.

⚠ CAUTION

The furnace area must be kept clear and free of combustible materials, gasoline, and other flammable vapors and liquids.

⚠ CAUTION

Insulating materials may be combustible. The furnace must be kept free and clear from insulating material. Examine the area around the furnace for insulation after installation or when insulation is added.

⚠ CAUTION

The combustion air for your furnace must be fresh uncontaminated air. Paints, varnishes, laundry bleaches, detergents, many household cleaners, water softening salts, adhesives, and all such products release fumes containing compounds which could lead to early heat exchanger and vent system deterioration. Do not store these types of products near your furnace.

⚠ CAUTION

For horizontally vented furnaces, the vent and inlet terminals must be located at least 12 inches minimum (18 inches in Canada) above normally expected snow accumulation level.

Proper Maintenance – Gas Furnaces

Air Filters

Clean the filter once a month for optimum performance. A monthly visual inspection of the furnace is also recommended. See General Inspection on page 9, number 1.

NOTE: Filters are NOT included with all Furnaces, however; the Furnace should never be run without a filter.

A clean filter saves money.

When the furnace circulates and filters the air in your home, dust and dirt particles build up on the filter. Excessive accumulation can block the airflow, forcing the unit to work harder to maintain desired temperatures.

And the harder your unit has to work, the more energy it uses. So you pay more any time your system is running with a dirty filter.

CAUTION

Never operate your unit for either heating or cooling with filters removed.

Help ensure top efficiency by cleaning the filter once a month. Clean it twice a month during seasons when the unit runs more often.

You can clean the filter with a vacuum, OR you can wash it with a household detergent.

NOTE: Not all aftermarket filters can be washed with a household detergent. See the instructions supplied by the aftermarket filter manufacturer.

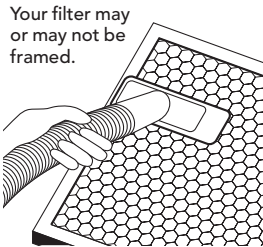

When replacing your furnace filters, always use a high velocity type which are the same size as originally supplied. Filters are available from your dealer.

Where disposable filters are used, they must be a high velocity type which are the same size as originally supplied.

How to remove the filter from your Gas Furnace.

WARNING

ELECTRIC SHOCK HAZARD

Disconnect power to unit before removing blower door. Failure to follow this warning could result in property damage, personal injury or death.

Upflow furnaces use a high velocity type air filter which may be located within the furnace blower compartment in either a BOTTOM or SIDE (left or right) return air inlet. The filter may be secured with filter retaining brackets (as shown) or a filter rack.

To clean or replace filters, remove blower access door, slide the filter from the filter rack or remove the filter from the retaining brackets. After cleaning, replace the filter in the same manner, making sure that the filter is secured in place in both the front and back filter retaining brackets, if present, or that the filter is securely

slid all the way into the filter rack. Replace blower access door. A bottom return air inlet as shown features a 17" x 25" x 1" filter in the 17-1/2" wide furnace; cabinets; a 20" x 25" x 1" filter in the 21" wide models; and a 24" x 25" x 1" filter in the 24-1/2" wide cabinet.

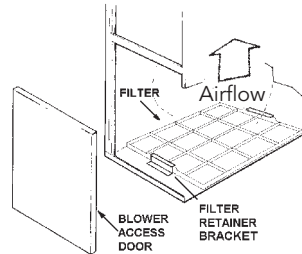

Upflow Bottom Return

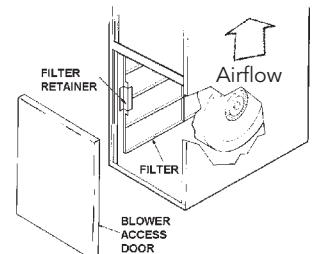

Upflow Side Return

For vertical UPFLOW ONLY, a left or right return air inlet as above (left side shown) requires trimming of the factory supplied filter to 17" x 25" x 1" for both the 21" and 24-1/2" wide furnaces.

Air filters may also be located outside of the furnace using a side filter frame.

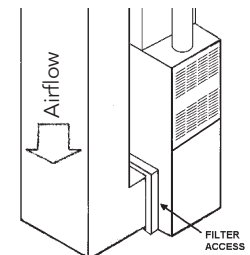

Upflow Only

Upflow/Horizontal Furnace Filters

The Upflow/Horizontal furnace when installed horizontally requires a horizontal filter kit. The filters may be located remote to the furnace or in the return air duct near the furnace. Check with your dealer for the location of your filters.

An upflow/horizontal furnace in horizontal return air filter application, as shown, features two 16" x 20" x 1" filters in the 17-1/2", 21" and 24-1/2" wide furnace cabinets.

To replace filters, remove the filter access door, lift the filter from the lower bracket and shift the filter to the side to free the top filter from the bracket and slide the filters out through the filter access door. After cleaning, replace the filters in the same manner making sure that the filters are secured in place in both top and bottom filter brackets. Replace filter access door.

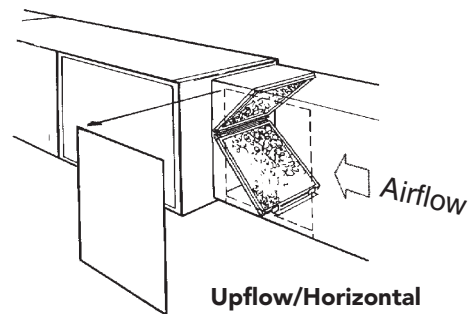

Upflow/Horizontal With Filter Kit

Proper Maintenance – Gas Furnaces

Air filters may also be located outside of the furnace using a remote filter grille. The filter grille could be in a hallway, wall, or in the ceiling. Check with your dealer for the exact location of your filter and the method of changing the filters.

Downflow/Horizontal furnaces are factory supplied with 2 standard size permanent type air filters which may be located remote to the furnace or in the return air duct. Check with your dealer for the location of your filters.

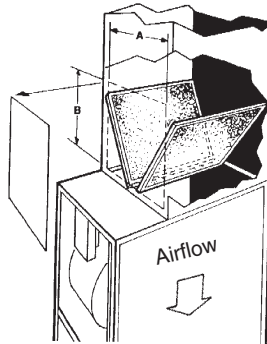

Downflow Filter

A downflow/horizontal furnace return air filter application, as shown, features two 14" x 20" x 1" filters in the 17-1/2" wide furnace cabinets; or two 16" x 20" x 1" filters in the 21" and 24-1/2" wide furnace cabinets.

For regular dealer maintenance please refer to www.acca.org/industry/quality

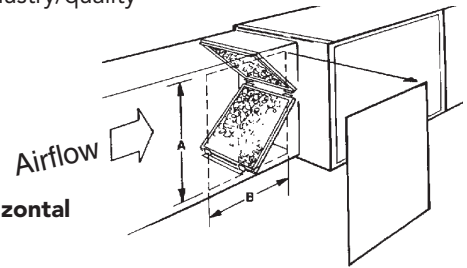

Downflow/Horizontal With Filter Kit

The Problem Solver – Gas Furnaces

Before you call for service, check the following:

Problem	Possible cause	Possible Remedy
No heating – Blower does not operate	<ol style="list-style-type: none"> 1. Thermostat set incorrectly 2. Blown fuse or tripped circuit breaker 3. Defective component 4. Burner does not ignite 5. Main gas line turned off 6. Blower door removed or ajar 7. Lockout 	<ol style="list-style-type: none"> 1. Adjust thermostat. See operating instructions. 2. Replace or reset protective device or call for servicer 3. Most controls are automatic and will recycle. If your unit still does not operate call for servicer. 4. Call servicer 5. Have gas company check 6. Close door securely to restore power to blower and gas valve 7. Turn power on-off-on-off twice in 30 seconds
Insufficient heating or cooling	<ol style="list-style-type: none"> 1. Dirty filters 2. Air not circulating freely 3. Blocked outdoor coil 	<ol style="list-style-type: none"> 1. Clean or replace 2. Check supply registers and return grills for blockage 3. Clear away leaves or other debris
No Heat – Vent motor is running	<ol style="list-style-type: none"> 1. Restricted or plugged furnace condensate drain 	<ol style="list-style-type: none"> 1. Remove drain clamps to condensate trap and drain pan outlet 2. Flush or clean drain blockage 3. Reinstall clamps
Unusual Noise		Call your local servicer

⚠ WARNING

CARBON MONOXIDE POISONING HAZARD

DO not attempt to change the venting system. Failure to follow the installation and operation instructions for the venting system's operation could result in carbon monoxide poisoning or death.

NOTE: Improperly sized vents can cause the formation of condensate, combustion gas leakage and spillage, and an inoperable furnace.

A furnace is not a household appliance. It is complex and requires professional maintenance and repair. Attempts at "do-it-yourself" repairs on an in-warranty unit may void the remainder of your warranty.

Other than performing the simple maintenance recommended in this manual, you should not attempt to make any adjustments to your furnace. Your dealer will be able to take care of any questions or problems you may have. A periodic inspection of your furnace should be made by a qualified service agency at the start of each heating season.

In the event that electrical, fuel, or mechanical failures occur, immediately turn the gas supply off at the manual gas valve located on the gas pipe leading to the furnace before turning off electrical power to the furnace. Contact a qualified service agency.

Keep your furnace looking like new for years.

Clean the enamel finish of your furnace with ordinary soap and water. For stubborn grease spots, use a household detergent. Lacquer thinner or other synthetic solvents may damage the finish.

Regular Dealer Maintenance

For regular dealer maintenance please refer to www.acca.org/industry/quality

To ensure proper operation of your furnace, the recommended dealer inspection is once a year, before the heating season. Regular maintenance must be performed by a qualified service professional.

The servicer should perform steps 1–9 once a year before the heating season.

The homeowner should perform the visual inspection in step 1 monthly when cleaning the furnace filter.

Unless it is an emergency, never stop the heating system by shutting off the main power.

If the main power to your air conditioner is ever disconnected for more than three hours, turn off the thermostat. Then wait for at least three more hours after the power has been restored before turning the thermostat back on. Failure to follow this procedure could result in damage to your furnace.

The following warning complies with State of California law, Proposition 65.

⚠ WARNING

HAZARDOUS GASES

Exposure to fuel substances or by-products of incomplete fuel combustion is believed by the state of California to cause cancer, birth defects, or other reproductive harm.

⚠ WARNING

HAZARDOUS GASES

Unit is equipped with a blower door switch which cuts power to blower and gas valve causing shutdown when door is removed. Unit must not be altered to allow operation with the blower door removed. Operation with doors removed or ajar can permit the escape of dangerous fumes. All panels must be securely closed at all times for safe operation of the furnace. Failure to follow this warning could result in property damage, personal injury or death.

⚠ WARNING

EXPLOSION HAZARD

In the event that electrical, fuel or mechanical failures occur, SHUT off the gas supply at the manual gas SHUT OFF valve, located ON THE SUPPLY GAS PIPING COMING INTO THE FURNACE, BEFORE TURNING OFF THE electrical power to the furnace. contact servicer.

Failure to follow this warning could result in property damage, personal injury or death.

⚠ CAUTION

Do NOT touch igniter. It is extremely hot.

⚠ WARNING

EXPLOSION HAZARD

Should overheating occur, or the gas supply fail to shut off, shut off the manual gas valve to the furnace before shutting off the electrical supply.

Failure to follow this warning could result in property damage, personal injury or death.

1. GENERAL INSPECTION – Examine the furnace installation for the following items:
 - a. All flue product carrying areas external to the furnace (i.e. chimney, vent connector) are clear and free of obstruction.
 - b. The vent connector is in place, slopes upward and is physically sound without holes or excessive corrosion.
 - c. The return air duct connection(s) is physically sound, is sealed to the furnace and terminates outside the space containing the furnace.
 - d. The physical support of the furnace should be sound without sagging, cracks, gaps, etc., around the base so as to provide a seal between the support and the base.
 - e. There are no obvious signs of deterioration of the furnace.
 - f. The burner flames are in good adjustment without erratic flames. See illustration below.
 - g. Fresh air inlet and vent are not blocked and free from obstruction. The horizontal or vertical vent and inlet must be located at least 12 inches minimum (18 inches in Canada) above the normally expected snow accumulation level.

Contact your service agent if you feel you are uncomfortable performing any of the inspections noted in section 1.

2. BLOWERS – The blower size and speed determine the air volume delivered by the furnace. The blower motor bearings are factory lubricated and under normal operating conditions usually do not require servicing. Annual cleaning of the blower wheel and housing is recommended for maximum air output, and this must be performed only by a qualified servicer or service agency.

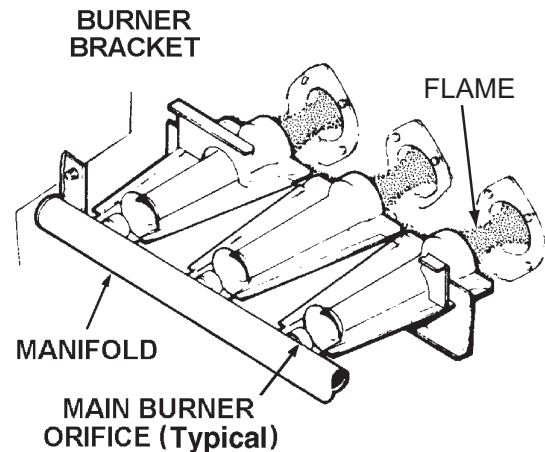

3. IGNITER – This unit has a special hot surface direct ignition device that automatically lights the burners. Please note that it is very fragile and should be handled with care.

Regular Dealer Maintenance

4. BURNER – Gas burners do not normally require scheduled servicing, however, accumulation of foreign material may cause a yellowing flame or delayed ignition. Either condition indicates that a service call is required. For best operation, burners must be cleaned annually using brushes and vacuum cleaner.

Turn off gas and electric power supply. To clean burners, remove top burner bracket and lift burner from orifice.

NOTE: Be careful not to break igniter when removing burners.

Clean burners with brush and/ or vacuum cleaner. Reassemble parts by reversal of the above procedure.

NOTE: On LP (propane) units, some light yellow tipping of the outer mantle is normal. Inner mantle should be bright blue. Natural gas units should not have any yellow tipped flames. This condition indicates that a service call is required. For best operation, burners must be cleaned annually using brushes and vacuum cleaner.

NOTE: On LP (propane) units, due to variations in BTU content and altitude, servicing may be required at shorter intervals.

5. HEAT EXCHANGER/ FLUE PIPE – These items must be inspected for signs of corrosion, and/ or deterioration at the beginning of each heating season by a qualified service technician and cleaned annually for best operation.

6. CIRCUIT PROTECTION – If blower or gas valve fail to operate, the cause could be the circuit breaker or a loose or blown fuse. Replace fuse or reset circuit breaker.

7. OPERATION – Your warm air furnace should not be operated in a corrosive atmosphere. Paint solvents, cleaning chemicals, spray propellants, and bleaches should not be used in the vicinity of the furnace during normal operation.

8. CONDENSATE DRAINS – If you have a cooling coil installed with your furnace, condensate drains should be checked and cleaned periodically to assure that condensate can drain freely from coil to drain. If condensate cannot drain freely water damage could occur. Furnace drain should also be checked and cleaned at the start of each heating season.

9. AIR CIRCULATION – To ensure increased comfort, the blower on this unit may be operated continuously for both heating and cooling. This will result in constantly filtered air and aid in maintaining more even temperatures by avoiding temperature stratification throughout the conditioned area. To accomplish constant air circulation, set your comfort control fan selector to "ON." Continuous fan mode during COOLING operation may not be appropriate in humid climates. If the indoor air exceeds 60% relative humidity or simply feels uncomfortably humid, it is recommended that the fan only be used in the "AUTO" mode.

Limited Warranty Information

Subject to the terms and conditions of this limited warranty, Trane U.S., Inc. ("Company") extends a limited warranty against manufacturing defects for the product(s) identified in Table 1 attached hereto ("Products") that are installed in a residential application (personal, family or household purposes) under normal use and maintenance in the United States and Canada.

This limited warranty applies to Products manufactured on or after August 1, 2011.

In order to maximize the available benefits under this limited warranty, the Purchaser (as defined below) should read it in its entirety. All repairs of Product parts covered under this limited warranty must be made with authorized service parts and by a licensed HVAC service provider. Additionally, commercial applications are treated differently under this limited warranty as stated in Table 1 attached hereto. For purposes of this limited warranty, "commercial applications" shall mean any application other than for personal, family, or household use.

TERM: The limited warranty period for Products is as stated in Table 1 attached hereto. If the Purchaser properly registers the Products, the limited warranty period shall be extended as stated in Table 1 attached hereto. Regardless of registration, the Commencement Date for a limited warranty period shall be the date that the original installation is complete and all Product start-up procedures have been properly completed and verified by an installer's invoice. If the installation and start-up date cannot be verified by the installer's invoice, the Commencement Date shall be sixty (60) days after the factory manufacture date which is verified by the Product serial number. Where a Product is installed in a newly constructed home, the Commencement Date is the date the Purchaser purchased the residence from the builder. Proof of Product purchase, installation, and/or closing date of the residence may be required to confirm the Commencement Date.

The installation of Product replacement parts under this limited warranty shall not extend the original warranty period. The warranty period for any Product part replaced under this limited warranty is the applicable warranty period remaining under the original Product warranty.

WHO IS COVERED: This limited warranty is provided only to the original owner and his or her spouse ("Purchaser") of the residence where the Products are originally installed. This warranty is not transferable except according to terms stated on the applicable website identified below under Registration Requirements. Company has the right to request any and all proof of Product purchase or installation and/or closing date of the residence.

WHAT COMPANY WILL DO: Company may request proof of Product purchase and/or installation in order to provide Product parts under this limited warranty. As Company's only responsibility and Purchaser's only remedy under this limited warranty, Company will furnish a replacement part to the licensed HVAC service provider, without charge for the part only, to replace any Product part that fails due to a manufacturing defect under normal use and maintenance. The Purchaser must pay for any and all shipping and handling charges and other costs of warranty service for the replacement part. If a Product part is not available, Company will, at its option, provide a free suitable substitute part or provide a credit in the amount of the then factory selling price for a new suitable substitute part to be used by the Purchaser towards the retail purchase price of a new Company product. Any new Product purchase shall be at Purchaser's sole cost and expense including, but not limited to, all shipping, removal, and installation costs and expenses.

REGISTRATION REQUIREMENTS: All Products must be properly registered online by the Purchaser within sixty (60) days after the Commencement Date to receive the registered limited warranty terms. To register online, go to:

<http://www.trane.com/Residential/Trane/Owners/Warranty-Information> or
<http://www.americanstandardair.com/servicesupport/pages/warranty.aspx>

and click "Begin Online Registration." If a Purchaser does not register within this stated time period, the base limited warranty terms shall apply.

ELIGIBILITY REQUIREMENTS: The following items are required in order for the Products to be covered under this limited warranty:

- The Products must be in the same location where they were originally installed.
- The Products must be properly installed, operated, and maintained by a licensed HVAC service provider in accordance with the Product specifications or installation, operation, and maintenance instructions provided by Company with each Product. Failure to conform to such specifications and/or instructions shall void this limited warranty. Company may request written documentation showing the proper preventative maintenance.
- All Product parts replaced by Company under this limited warranty must be given to the servicing provider for return to Company.

- Air handlers, air conditioners, heat pumps, cased or uncased coils and stand-alone furnaces must be part of an Air Conditioning, Heating, and Refrigeration Institute rated and matched system or a specification in a Company provided bulletin or otherwise approved in writing by a Company authorized representative.

EXCLUSIONS: The following are not covered by this limited warranty:

- Labor costs including, but not limited to, costs for diagnostic calls or the removal and reinstallation of Products and/or Product parts.
- Shipping and freight expenses required to ship Product replacement parts.
- Failures, defects, or damage (including, but not limited to, any loss of data or property) caused by (1) any third party product, service, or system connected or used in conjunction with the Products; (2) any use that is not designed or intended for the Products; (3) modification, alteration, abuse, misuse, negligence, or accident; (4) improper storage, installation, maintenance, or operation including, but not limited to, operation of electrical equipment at voltages other than the range specified on the Product nameplate; (5) any use in violation of written instructions or specifications provided by Company; (6) any acts of God including, but not limited to, fire, water, storms, lightning, or earthquakes; or any theft or riots; or (7) a corrosive atmosphere or contact with corrosive materials such as, but not limited to, chlorine, fluorine, salt (provided that indoor and outdoor coils will only be covered if a Sea Coast Kit is installed), sulfur, recycled waste water, urine, fertilizers, rust, or other damaging substances or chemicals.
- Products purchased direct including, but not limited to, Internet or auction purchases and purchases made on an uninstalled basis.
- 3 phase models, cabinets or cabinet pieces that do not affect product performance, air filters, refrigerant, refrigerant line sets, belts, wiring, fuses, surge protection devices, non-factory installed driers, and Product accessories.
- Increased utility usage costs.

REFRIGERANT POLICY: Beginning on January 1, 2010, R-22 refrigerant will no longer be used

as a manufacturer-installed refrigerant as required by federal regulation. Any and all expenses or costs associated with replacing Product parts that are not R-410A compatible will not be covered by the terms and conditions of this limited warranty. In addition, all Products containing R-410A refrigerant include a liquid line filter drier which must be replaced when a compressor replacement is necessary. A suction line filter drier must be added for compressors defined as burnouts. Failure to comply with such filter drier requirements or the use of contaminated or alternate refrigerant or any non-approved refrigerant system additives including, but not limited to, dyes, will void this limited warranty.

ADDITIONAL TERMS:

THIS LIMITED WARRANTY AND LIABILITY SET FORTH HEREIN ARE IN LIEU OF ALL OTHER WARRANTIES AND LIABILITIES, WHETHER IN CONTRACT OR IN NEGLIGENCE, EXPRESS OR IMPLIED, IN LAW OR IN FACT. THE IMPLIED WARRANTIES OF MERCHANTABILITY AND FITNESS FOR A PARTICULAR PURPOSE ARE LIMITED TO THE DURATION OF THE APPLICABLE PRODUCT WARRANTY. COMPANY DOES NOT AUTHORIZE ANY PERSON TO CREATE FOR IT ANY OBLIGATION OR LIABILITY IN CONNECTION WITH THE PRODUCTS.

NOTWITHSTANDING ANYTHING IN THIS LIMITED WARRANTY TO THE CONTRARY, COMPANY SHALL NOT BE LIABLE FOR ANY INCIDENTAL, CONSEQUENTIAL, INDIRECT, SPECIAL AND/OR PUNITIVE DAMAGES, WHETHER BASED ON CONTRACT, WARRANTY, TORT (INCLUDING, BUT NOT LIMITED TO, STRICT LIABILITY OR NEGLIGENCE), PATENT INFRINGEMENT, OR OTHERWISE, EVEN IF ADVISED OF THE POSSIBILITY OF SUCH DAMAGES. COMPANY'S MAXIMUM LIABILITY HEREUNDER IS LIMITED TO THE ORIGINAL PURCHASE PRICE OF THE PRODUCTS.

No action arising out of any claimed breach of this limited warranty may be brought by a Purchaser more than one (1) year after the cause of action has arisen.

This limited warranty gives you specific legal rights, and you may also have other rights as otherwise permitted by law. If this Product is considered a consumer product, please be advised that some local laws do not allow limitations on incidental or consequential damages, how long a warranty lasts based on registration, or how long an implied warranty lasts, so that the above limitations may not fully apply. Refer to your local laws for your specific rights under this limited warranty.

Residential Systems
6200 Troup Highway, Tyler, TX 75707
Attn: Customer Relations

Or visit our website at www.trane.com or www.americanstandardair.com

Important Product Information

Thank you for purchasing Trane home comfort products. Registering your products helps us provide you with one of the strongest manufacturer limited warranties available. Product registration can be completed either online at Trane.com or by calling 800-554-6413. You will need the serial number, model number, and installation date for each product being registered. Your dealer may have included these on your invoice or can provide a list for you to use. Please take a few moments to record the following information to ensure your product registration process is quick and easy:

Air Handler/Furnace Serial Number _____

Air Handler/Furnace Model Number _____

Indoor Coil Serial Number _____

Indoor Coil Model Number _____

Date of Installation _____

Dealer _____

Service Information

Call your installing dealer if the unit is inoperative. Before you call, always check the following to be sure service is required:

- a. Be sure the main switch that supplies power to the unit is in the ON position.
- b. Replace any burned-out fuses or reset circuit breakers.
- c. Be sure the thermostat is properly set.

Service Phone _____



It's Hard To Stop A Trane.®

www.trane.com

Ingersoll Rand Residential Solutions, a business comprised of well-known brands like Schlage and Trane, delivers safety, comfort and efficiency to homeowners throughout North America. Our quality products, services and solutions include mechanical and electronic locks, heating and air conditioning systems, indoor air quality solutions, advanced controls, portable security systems and remote home management. For more information on these and other residential solutions please visit www.ingersollrand.com, www.schlage.com, or www.trane.com.